

# Data sheet | Item number: 765-4202/100-000

8-Port-IO Link Master Class B; EtherCAT; DC 24 V / 2.0 A; 8xM12 connection; WideLine



[www.wago.com/765-4202/100-000](http://www.wago.com/765-4202/100-000)



Picture differs from the item.

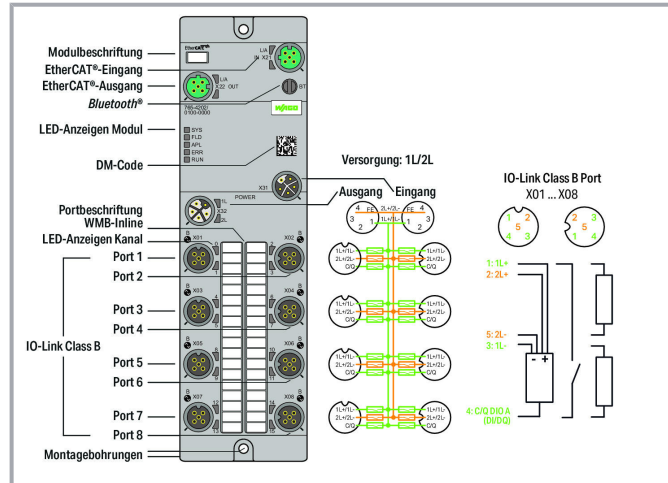

## Data

### Technical data

### Fieldbus

Communication	EtherCAT AoE, EoE, FoE
Connection technology: communication/fieldbus	2 x D-coded M12; 4-pole
Interface standard	10BASE-T/100BASE-TX; potential-free
Autonegotiation; autocrossover	yes

### Device Functions

Parameters	Input filter Output current
------------	--------------------------------

Subject to changes. Please also observe the further product documentation!

WAGO GmbH & Co. KG  
Hansastr. 27  
32423 Minden  
Phone: +49571 887-0 | Fax: +49571 887-169  
Email: [info.de@wago.com](mailto:info.de@wago.com) | Web: [www.wago.com](http://www.wago.com)

Do you have any questions about our products?  
We are always happy to take your call at +49 (571) 887-44222.



	Temperature
Diagnostics	Undervoltage; Overcurrent; Overload; Overtemperature
Device functions	Bluetooth® OPC UA Server
Visualization	Android/iOS app Webserver

## IO-Link Master

IO-Link Master classification	Class B; Specification V1.1
Port mode	IO-Link: autoconfig, manual, tool-based DI DO
Cycle time	400 µs (min.)
Operating mode	IO-Link master, DI or DO (adjustable for pin 4 per port); Supply voltage 2L (fixed for pin 2 per port)

## IO-Link ports

Number of digital inputs	8
Number of digital outputs	8
Connection technology: inputs/outputs	8 x A-coded M12; 5-pole
Voltage signal type	24 VDC
Input characteristic	High-side switching
Input filter	0.2 ... 20 ms
Input characteristic	Type 3, per IEC 61131-2
Output current (per channel)	2 A (typ.) for DO
Supply current per port	1L (Pin 1): 1 A for IO-Link; 4 A (max.) for DIO; 2L (Pin 2): 4 A (max.)

## Module Power Supply

Connection technology: supply	2 x L-coded M12; 5-pole
Supply voltage	24 VDC (18 ... 31.2 V); 1L/2L
Power consumption (max.)	16000 mA
Power consumption (note)	per supply line; overload- and short-circuit-protected
Reverse voltage protection	Yes

## Geometrical Data

Width	60 mm / 2.362 inch
Height	30 mm / 1.181 inch
Depth	210 mm / 8.268 inch

Subject to changes. Please also observe the further product documentation!

WAGO GmbH & Co. KG  
Hansastr. 27  
32423 Minden  
Phone: +49571 887-0 | Fax: +49571 887-169  
Email: [info.de@wago.com](mailto:info.de@wago.com) | Web: [www.wago.com](http://www.wago.com)

Do you have any questions about our products?  
We are always happy to take your call at +49 (571) 887-44222.

## Mechanical Data

Weight	610 g
Conformity marking	CE

## Environmental Requirements

Surrounding air temperature (operation)	-25 ... +70 °C
Surrounding air temperature (storage)	-40 ... +80 °C
Protection type	IP67
Protection class	III per EN 61140, IEC 61140, VDE 0140-1
Operating altitude	0 ... 2000 m
Pollution degree (5)	3 per EN 60664-1
Overvoltage category	II (EN 60664-1)
Relative humidity (without condensation)	95 %
Vibration resistance	5g per IEC 60068-2-6
Shock resistance	Short-term: 50g/11 ms/half-sine per IEC 60068-2-27; Long-term: 30g/6 ms/half-sine per IEC 60068-2-29
EMC immunity to interference	per EN 61000-6-2
EMC emission of interference	per EN 61000-6-4

## Commercial data

PU (SPU)	1 Pieces
Country of origin	DE
GTIN	4055144010084
Customs tariff number	85371098990

## Required accessories

### Cover

Cover		
	<b>Item no.: 756-8102</b> M12 protective cap; for unused sockets	<a href="http://www.wago.com/756-8102">www.wago.com/756-8102</a>
	<b>Item no.: 756-8103</b> M12 protective cap; for unused plugs	<a href="http://www.wago.com/756-8103">www.wago.com/756-8103</a>

### Tool

Assembly tool		
	<b>Item no.: 206-701</b> Torque wrench M8 and M12; Assembly kit	<a href="http://www.wago.com/206-701">www.wago.com/206-701</a>

Subject to changes. Please also observe the further product documentation!

## Marking accessories

### Marking strip



**Item no.: 2009-110**

Marking strips; for Smart Printer; on reel; not stretchable; plain; snap-on type; white

[www.wago.com/2009-110](http://www.wago.com/2009-110)

### Marker



**Item no.: 2009-115**

WMB-Inline; for Smart Printer; 1500 pieces on roll; stretchable 5 - 5.2 mm; plain; snap-on type; white

[www.wago.com/2009-115](http://www.wago.com/2009-115)

## Optional accessories

### Cables and pluggable connectors

#### Sensor/actuator cable

**Item no.: 756-5402/050-010**

Sensor/Actuator cable; M12A socket; straight; M12A plug; angled; 5-pole; Length: 1 m

[www.wago.com/756-5402/050-010](http://www.wago.com/756-5402/050-010)

**Item no.: 756-5311/050-015**

Sensor/Actuator cable; M12A plug; straight; 5-pole; Length: 1.5 m

[www.wago.com/756-5311/050-015](http://www.wago.com/756-5311/050-015)

**Item no.: 756-5404/050-020**

Sensor/Actuator cable; M12A socket; angled; M12A plug; angled; 5-pole; Length: 2 m

[www.wago.com/756-5404/050-020](http://www.wago.com/756-5404/050-020)

**Item no.: 756-5404/050-010**

Sensor/Actuator cable; M12A socket; angled; M12A plug; angled; 5-pole; Length: 1 m

[www.wago.com/756-5404/050-010](http://www.wago.com/756-5404/050-010)

**Item no.: 756-5402/050-020**

Sensor/Actuator cable; M12A socket; straight; M12A plug; angled; 5-pole; Length: 2 m

[www.wago.com/756-5402/050-020](http://www.wago.com/756-5402/050-020)

**Item no.: 756-5312/050-015**

Sensor/Actuator cable; M12B socket; straight; 5-pole; Length: 1.5 m

[www.wago.com/756-5312/050-015](http://www.wago.com/756-5312/050-015)

**Item no.: 756-5312/050-050**

Sensor/Actuator cable; M12B socket; straight; 5-pole; Length: 5 m

[www.wago.com/756-5312/050-050](http://www.wago.com/756-5312/050-050)

**Item no.: 756-5312/050-100**

Sensor/Actuator cable; M12B socket; straight; 5-pole; Length: 10 m

[www.wago.com/756-5312/050-100](http://www.wago.com/756-5312/050-100)

**Item no.: 756-5403/050-020**

Sensor/Actuator cable; M12A socket; angled; M12A plug; straight; 5-pole; Length: 2 m

[www.wago.com/756-5403/050-020](http://www.wago.com/756-5403/050-020)

Subject to changes. Please also observe the further product documentation!

WAGO GmbH & Co. KG

Hansastr. 27

32423 Minden

Phone: +49571 887-0 | Fax: +49571 887-169

Email: [info.de@wago.com](mailto:info.de@wago.com) | Web: [www.wago.com](http://www.wago.com)

Do you have any questions about our products?

We are always happy to take your call at +49 (571) 887-44222.

**Item no.: 756-5403/050-010**  
Sensor/Actuator cable; M12A socket; angled; M12A plug; straight; 5-pole; Length: 1 m

[www.wago.com/756-5403/050-010](http://www.wago.com/756-5403/050-010)

**Item no.: 756-5311/050-100**  
Sensor/Actuator cable; M12A plug; straight; 5-pole; Length: 10 m

[www.wago.com/756-5311/050-100](http://www.wago.com/756-5311/050-100)

**Item no.: 756-5311/050-050**  
Sensor/Actuator cable; M12A plug; straight; 5-pole; Length: 5 m

[www.wago.com/756-5311/050-050](http://www.wago.com/756-5311/050-050)

**Item no.: 756-5401/050-010**  
Sensor/Actuator cable; M12A socket; straight; M12A plug; straight; 5-pole; Length: 1 m

[www.wago.com/756-5401/050-010](http://www.wago.com/756-5401/050-010)

**Item no.: 756-5401/050-020**  
Sensor/Actuator cable; M12A socket; straight; M12A plug; straight; 5-pole; Length: 2 m

[www.wago.com/756-5401/050-020](http://www.wago.com/756-5401/050-020)

#### Configurable connectors

**Item no.: 756-9202/050-000**  
Fitted pluggable connector; 5-pole; M12 plug, straight, A-coded; Spring

[www.wago.com/756-9202/050-000](http://www.wago.com/756-9202/050-000)

**Item no.: 756-9205/050-000**  
Fitted pluggable connector; 5-pole; M12 plug, right angle; Spring

[www.wago.com/756-9205/050-000](http://www.wago.com/756-9205/050-000)



**Item no.: 756-9711/050-000**  
Fitted pluggable connector; 5-pole, shielded; M12 socket, straight; IDC technology

[www.wago.com/756-9711/050-000](http://www.wago.com/756-9711/050-000)



**Item no.: 756-9701/050-000**  
Fitted pluggable connector; 5-pole, shielded; M12 plug, straight; IDC technology

[www.wago.com/756-9701/050-000](http://www.wago.com/756-9701/050-000)

#### Configurable shielded connectors

**Item no.: 756-9501/060-000**  
Fitted pluggable connector; 5-pole, shielded; M12 plug, straight, D-coded; Spring

[www.wago.com/756-9501/060-000](http://www.wago.com/756-9501/060-000)

**Item no.: 756-9501/040-000**  
Accessories; M12 plug, right angle; 4-pole

[www.wago.com/756-9501/040-000](http://www.wago.com/756-9501/040-000)











#### Power cable















**Item no.: 756-3501/050-075**  
Power cable; M12L socket; straight; 5-pole; Length: 7.5 m

[www.wago.com/756-3501/050-075](http://www.wago.com/756-3501/050-075)













Subject to changes. Please also observe the further product documentation!

	<b>Item no.: 756-3501/050-100</b> Power cable; M12L socket; straight; 5-pole; Length: 10 m	<a href="http://www.wago.com/756-3501/050-100">www.wago.com/756-3501/050-100</a>
	<b>Item no.: 756-3501/050-150</b> Power cable; M12L socket; straight; 5-pole; Length: 15 m	<a href="http://www.wago.com/756-3501/050-150">www.wago.com/756-3501/050-150</a>
	<b>Item no.: 756-3501/050-050</b> Power cable; M12L socket; straight; 5-pole; Length: 5 m	<a href="http://www.wago.com/756-3501/050-050">www.wago.com/756-3501/050-050</a>
	<b>Item no.: 756-3502/050-050</b> Power cable; M12L socket; angled; 5-pole; Length: 5 m	<a href="http://www.wago.com/756-3502/050-050">www.wago.com/756-3502/050-050</a>
	<b>Item no.: 756-3502/050-150</b> Power cable; M12L socket; angled; 5-pole; Length: 15 m	<a href="http://www.wago.com/756-3502/050-150">www.wago.com/756-3502/050-150</a>
	<b>Item no.: 756-3502/050-075</b> Power cable; M12L socket; angled; 5-pole; Length: 7.5 m	<a href="http://www.wago.com/756-3502/050-075">www.wago.com/756-3502/050-075</a>
	<b>Item no.: 756-3502/050-100</b> Power cable; M12L socket; angled; 5-pole; Length: 10 m	<a href="http://www.wago.com/756-3502/050-100">www.wago.com/756-3502/050-100</a>
	<b>Item no.: 756-3503/050-075</b> Power cable; M12L plug; straight; 5-pole; Length: 7.5 m	<a href="http://www.wago.com/756-3503/050-075">www.wago.com/756-3503/050-075</a>
	<b>Item no.: 756-3503/050-150</b> Power cable; M12L plug; straight; 5-pole; Length: 15 m	<a href="http://www.wago.com/756-3503/050-150">www.wago.com/756-3503/050-150</a>
	<b>Item no.: 756-3503/050-100</b> Power cable; M12L plug; straight; 5-pole; Length: 10 m	<a href="http://www.wago.com/756-3503/050-100">www.wago.com/756-3503/050-100</a>
	<b>Item no.: 756-3505/050-003</b> Power cable; M12L socket; straight; M12L plug; straight; 5-pole; Length: 0.3 m	<a href="http://www.wago.com/756-3505/050-003">www.wago.com/756-3505/050-003</a>

Subject to changes. Please also observe the further product documentation!

	<b>Item no.: 756-3505/050-005</b> Power cable; M12L socket; straight; M12L plug; straight; 5-pole; Length: 0.5 m	<a href="http://www.wago.com/756-3505/050-005">www.wago.com/756-3505/050-005</a>
	<b>Item no.: 756-3505/050-020</b> Power cable; M12L socket; straight; M12L plug; straight; 5-pole; Length: 2 m	<a href="http://www.wago.com/756-3505/050-020">www.wago.com/756-3505/050-020</a>
	<b>Item no.: 756-3505/050-010</b> Power cable; M12L socket; straight; M12L plug; straight; 5-pole; Length: 1 m	<a href="http://www.wago.com/756-3505/050-010">www.wago.com/756-3505/050-010</a>
	<b>Item no.: 756-3505/050-050</b> Power cable; M12L socket; straight; M12L plug; straight; 5-pole; Length: 5 m	<a href="http://www.wago.com/756-3505/050-050">www.wago.com/756-3505/050-050</a>
	<b>Item no.: 756-3505/050-075</b> Power cable; M12L socket; straight; M12L plug; straight; 5-pole; Length: 7.5 m	<a href="http://www.wago.com/756-3505/050-075">www.wago.com/756-3505/050-075</a>
	<b>Item no.: 756-3505/050-100</b> Power cable; M12L socket; straight; M12L plug; straight; 5-pole; Length: 10 m	<a href="http://www.wago.com/756-3505/050-100">www.wago.com/756-3505/050-100</a>
	<b>Item no.: 756-3506/050-100</b> Power cable; M12L socket; angled; M12L plug; angled; 5-pole; Length: 10 m	<a href="http://www.wago.com/756-3506/050-100">www.wago.com/756-3506/050-100</a>
	<b>Item no.: 756-3506/050-075</b> Power cable; M12L socket; angled; M12L plug; angled; 5-pole; Length: 7.5 m	<a href="http://www.wago.com/756-3506/050-075">www.wago.com/756-3506/050-075</a>
	<b>Item no.: 756-3506/050-150</b> Power cable; M12L socket; angled; M12L plug; angled; 5-pole; Length: 15 m	<a href="http://www.wago.com/756-3506/050-150">www.wago.com/756-3506/050-150</a>
	<b>Item no.: 756-3501/050-020</b> Power cable; M12L socket; straight; 5-pole; Length: 2 m	<a href="http://www.wago.com/756-3501/050-020">www.wago.com/756-3501/050-020</a>
	<b>Item no.: 756-3502/050-020</b> Power cable; M12L socket; angled; 5-pole; Length: 2 m	<a href="http://www.wago.com/756-3502/050-020">www.wago.com/756-3502/050-020</a>
	<b>Item no.: 756-3503/050-020</b> Power cable; M12L plug; straight; 5-pole; Length: 2 m	<a href="http://www.wago.com/756-3503/050-020">www.wago.com/756-3503/050-020</a>

Subject to changes. Please also observe the further product documentation!

	<b>Item no.: 756-3503/050-050</b> Power cable; M12L plug; straight; 5-pole; Length: 5 m	<a href="http://www.wago.com/756-3503/050-050">www.wago.com/756-3503/050-050</a>
	<b>Item no.: 756-3504/050-020</b> Power cable; M12L plug; angled; 5-pole; Length: 2 m	<a href="http://www.wago.com/756-3504/050-020">www.wago.com/756-3504/050-020</a>
	<b>Item no.: 756-3504/050-050</b> Power cable; M12L plug; angled; 5-pole; Length: 5 m	<a href="http://www.wago.com/756-3504/050-050">www.wago.com/756-3504/050-050</a>
	<b>Item no.: 756-3504/050-075</b> Power cable; M12L plug; angled; 5-pole; Length: 7.5 m	<a href="http://www.wago.com/756-3504/050-075">www.wago.com/756-3504/050-075</a>
	<b>Item no.: 756-3504/050-100</b> Power cable; M12L plug; angled; 5-pole; Length: 10 m	<a href="http://www.wago.com/756-3504/050-100">www.wago.com/756-3504/050-100</a>
	<b>Item no.: 756-3504/050-150</b> Power cable; M12L plug; angled; 5-pole; Length: 15 m	<a href="http://www.wago.com/756-3504/050-150">www.wago.com/756-3504/050-150</a>
	<b>Item no.: 756-3505/050-150</b> Power cable; M12L socket; straight; M12L plug; straight; 5-pole; Length: 15 m	<a href="http://www.wago.com/756-3505/050-150">www.wago.com/756-3505/050-150</a>
	<b>Item no.: 756-3506/050-003</b> Power cable; M12L socket; angled; M12L plug; angled; 5-pole; Length: 0.3 m	<a href="http://www.wago.com/756-3506/050-003">www.wago.com/756-3506/050-003</a>
	<b>Item no.: 756-3506/050-005</b> Power cable; M12L socket; angled; M12L plug; angled; 5-pole; Length: 0.5 m	<a href="http://www.wago.com/756-3506/050-005">www.wago.com/756-3506/050-005</a>
	<b>Item no.: 756-3506/050-020</b> Power cable; M12L socket; angled; M12L plug; angled; 5-pole; Length: 2 m	<a href="http://www.wago.com/756-3506/050-020">www.wago.com/756-3506/050-020</a>
	<b>Item no.: 756-3506/050-010</b> Power cable; M12L socket; angled; M12L plug; angled; 5-pole; Length: 1 m	<a href="http://www.wago.com/756-3506/050-010">www.wago.com/756-3506/050-010</a>
	<b>Item no.: 756-3506/050-050</b> Power cable; M12L socket; angled; M12L plug; angled; 5-pole; Length: 5 m	<a href="http://www.wago.com/756-3506/050-050">www.wago.com/756-3506/050-050</a>
Distribution connector		

Subject to changes. Please also observe the further product documentation!





**Item no.: 756-9301/050-000**  
Accessories; 5-pole

[www.wago.com/756-9301/050-000](http://www.wago.com/756-9301/050-000)

---

ETHERNET/PROFINET cable

---



**Item no.: 756-1202/060-200**  
ETHERNET cable; M12D plug; angled; 4-pole; Length: 20 m

[www.wago.com/756-1202/060-200](http://www.wago.com/756-1202/060-200)



**Item no.: 756-1201/060-100**  
ETHERNET cable; M12D plug; straight; 4-pole; Length: 10 m

[www.wago.com/756-1201/060-100](http://www.wago.com/756-1201/060-100)



**Item no.: 756-1201/060-050**  
ETHERNET cable; M12D plug; straight; 4-pole; Length: 5 m

[www.wago.com/756-1201/060-050](http://www.wago.com/756-1201/060-050)



**Item no.: 756-1203/060-050**  
ETHERNET cable; M12D plug; straight; M12D plug; straight; 4-pole; Length: 5 m

[www.wago.com/756-1203/060-050](http://www.wago.com/756-1203/060-050)



**Item no.: 756-1203/060-020**  
ETHERNET cable; M12D plug; straight; M12D plug; straight; 4-pole; Length: 2 m

[www.wago.com/756-1203/060-020](http://www.wago.com/756-1203/060-020)



**Item no.: 756-1202/060-020**  
ETHERNET cable; M12D plug; angled; 4-pole; Length: 2 m

[www.wago.com/756-1202/060-020](http://www.wago.com/756-1202/060-020)



**Item no.: 756-1201/060-200**  
ETHERNET cable; M12D plug; straight; 4-pole; Length: 20 m

[www.wago.com/756-1201/060-200](http://www.wago.com/756-1201/060-200)



**Item no.: 756-1204/060-050**  
ETHERNET cable; M12D plug; angled; M12D plug; angled; 4-pole; Length: 5 m

[www.wago.com/756-1204/060-050](http://www.wago.com/756-1204/060-050)



**Item no.: 756-1204/060-100**  
ETHERNET cable; M12D plug; angled; M12D plug; angled; 4-pole; Length: 10 m

[www.wago.com/756-1204/060-100](http://www.wago.com/756-1204/060-100)



**Item no.: 756-1204/060-200**  
ETHERNET cable; M12D plug; angled; M12D plug; angled; 4-pole; Length: 20 m

[www.wago.com/756-1204/060-200](http://www.wago.com/756-1204/060-200)

---

Subject to changes. Please also observe the further product documentation!

	<b>Item no.:</b> 756-1203/060-200 ETHERNET cable; M12D plug; straight; M12D plug; straight; 4-pole; Length: 20 m	<a href="http://www.wago.com/756-1203/060-200">www.wago.com/756-1203/060-200</a>
	<b>Item no.:</b> 756-1203/060-100 ETHERNET cable; M12D plug; straight; M12D plug; straight; 4-pole; Length: 10 m	<a href="http://www.wago.com/756-1203/060-100">www.wago.com/756-1203/060-100</a>
	<b>Item no.:</b> 756-1204/060-010 ETHERNET cable; M12D plug; angled; M12D plug; angled; 4-pole; Length: 0.1 m	<a href="http://www.wago.com/756-1204/060-010">www.wago.com/756-1204/060-010</a>
	<b>Item no.:</b> 756-1204/060-030 ETHERNET cable; M12D plug; angled; M12D plug; angled; 4-pole; Length: 3 m	<a href="http://www.wago.com/756-1204/060-030">www.wago.com/756-1204/060-030</a>
	<b>Item no.:</b> 756-1204/060-020 ETHERNET cable; M12D plug; angled; M12D plug; angled; 4-pole; Length: 2 m	<a href="http://www.wago.com/756-1204/060-020">www.wago.com/756-1204/060-020</a>
	<b>Item no.:</b> 756-1202/060-050 ETHERNET cable; M12D plug; angled; 4-pole; Length: 5 m	<a href="http://www.wago.com/756-1202/060-050">www.wago.com/756-1202/060-050</a>
	<b>Item no.:</b> 756-1202/060-100 ETHERNET cable; M12D plug; angled; 4-pole; Length: 10 m	<a href="http://www.wago.com/756-1202/060-100">www.wago.com/756-1202/060-100</a>
	<b>Item no.:</b> 756-1201/060-020 ETHERNET cable; M12D plug; straight; 4-pole; Length: 2 m	<a href="http://www.wago.com/756-1201/060-020">www.wago.com/756-1201/060-020</a>

## Downloads

### Documentation

#### Manual

8-Port-IO Link Master Class B; EtherCAT; 24 VDC / 2.0 A; 8xM12 Connection; WideLine	V 1.0.0 2021年6月8日	pdf 6.6 MB	Download
--	----------------------	---------------	----------

#### System Description

WAGO I/O System Field; General Product Information	pdf 708.2 kB	Download
--	-----------------	----------

Subject to changes. Please also observe the further product documentation!



## Engineering-Software

### WAGO IO-Link Configurator

WAGO IO-Link Configurator	V5.1.1-6015	ZIP	Download
	2021年8月24日	159.6 MB	

WAGO IO-Link Configurator allows configuration, parameterization, operation and monitoring of WAGO IO-Link Masters in the WAGO I/O System 750 and WAGO I/O System Field, and especially of the WAGO IO-Link devices connected to them.

Additionally, WAGO IO-Link Configurator can be used for complete configuration and operation of all IO-Link devices of third-party manufacturers, as long as they comply with the IO-Link specification. A product's process data can be visualized graphically and stored in trend curves. Up to eight elements can be selected for visualization, and the data can be recorded for up to 24 hours.

Device description files for the IO-Link Masters (IOLM) or IO-Link Devices (IODD) can be used to integrate new devices into the tool at any time. Convenient access to the IO-Link user organization's IODDfinder is available for the IODDs. This allows automated, selective download of IODDs when integrating new IO-Link devices. An integrated IODD viewer allows detailed insight into the IODD device description.

WAGO IO-Link Configurator can be used either as a standalone program or integrated into engineering systems with a TCI interface and *WAGO-I/O-CHECK*.

IO-Link Configurator can also be used to integrate the IO-Link Master (750-657) of the WAGO I/O System 750 Series and to access all the configurator's functions. This is made possible by the WAGO I/O System 750 IO-Link Adapter, which can be retrofitted. The WAGO I/O System 750 IO-Link Adapter requires the current version of WAGO IO-Link Configurator and a current version of *WAGO-I/O-CHECK*.

In addition, the download file contains the device descriptions for the respective fieldbus systems of the WAGO I/O System Field modules. These are pre-installed in the Configurator setup.

The WAGO IO-Link Configurator license is assigned to the specific PC on which it is installed (a workstation license).

Register now and test our engineering software for 30 days at no cost.

## Runtime Software

### Firmware

EtherCat IO-Field 765-x2xx Firmware Download	V 01	zip	Download
WAGO_FW0765-x2xx_V01010017_IX01.zip	2021年7月23日	1.6 MB	

## CAD/CAE-Data

### CAD data

2D/3D Models 765-4202/100-000		URL	Download
-------------------------------	--	-----	----------

## Device Files

### Device Description File

(750-909) ESI file for EtherCAT 750 Series and 765 Series	23	zip	Download
---	----	-----	----------

Subject to changes. Please also observe the further product documentation!

WAGO GmbH & Co. KG  
 Hansastr. 27  
 32423 Minden  
 Phone: +49571 887-0 | Fax: +49571 887-169  
 Email: [info.de@wago.com](mailto:info.de@wago.com) | Web: [www.wago.com](http://www.wago.com)

Do you have any questions about our products?  
 We are always happy to take your call at +49 (571) 887-44222.



2021年7月9日

216.9 kB

Gerätebeschreibungsdateien 765-42xx, 765-12xx, EtherCAT

V1\_1\_0\_17

zip  
72 B

Download

## Environmental Product Compliance

### Compliance Search

Environmental Product Compliance 765-4202/100-000

URL

Download

8-Port-IO Link Master Class B; EtherCAT; DC 24 V / 2.0 A; 8xM12 connection;  
WideLine

## Installation Notes

## Product family

WAGO I/O System Field

[Show all products from the family](#)

Subject to changes. Please also observe the further product documentation!

WAGO GmbH & Co. KG

Hansastr. 27

32423 Minden

Phone: +49571 887-0 | Fax: +49571 887-169

Email: [info.de@wago.com](mailto:info.de@wago.com) | Web: [www.wago.com](http://www.wago.com)

Do you have any questions about our products?

We are always happy to take your call at +49 (571) 887-44222.